

ASSEMBLY AND INSTRUCTION MANUAL BLUE MODEL 0221 WUMMS!

© 2021 KURT BEIER & KATI QUINGER



Big sofa on a covered plateau



Optionally with motorised
seat adjustment



Luxurious with high quality
spring core



Loosely inserted seat cushions

Mounting of connectors

1. Position the elements at the place supposed to stay.

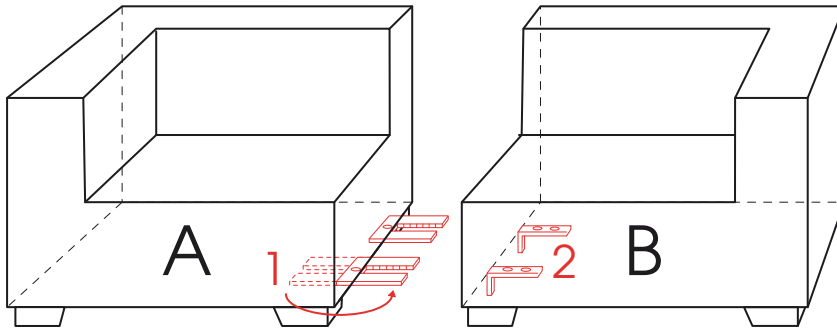

2. Turn connector ratchet 1 of element A to the outside.

3. Firmly push together part A and B, until metal guides 2 catch into guides 1.

4. In case of dismounting lift part B with the metal guides 2 and pull away.

FUNKI - how it works:

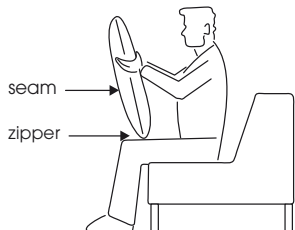

1. Take the cushion at its upper side and put the cushion on your knees with the zipper on the bottom. The seamless side faces you.

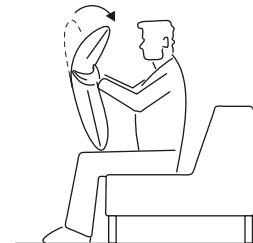

2. Move the upper part of the cushion towards yourself until the final position is reached.

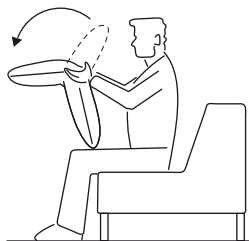

3. Now you are able to move the upper part backwards until the upper part of the cushion will click into place in the zero position.

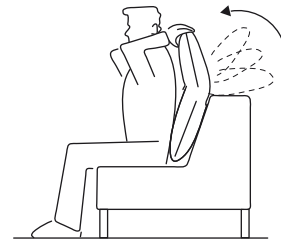

4. Now put the cushion in the preferred position (e.g. in the back, seamless side at the front and zipper at the bottom). You are able to choose different locking positions depending on your preference and position by slowly pulling the upper part of the cushion towards yourself.

Use of motorised seat adjustment:

1. Insert the plug A into the charging socket at the bottom of the sofa and then the transformer into the socket.
2. By pressing the switch buttons B and C at remote control, the seat can be moved continuously to the required position.

Charging socket



The charging socket is always located on the back of the connector side.

Power supply

TRANSFORMER

Attention!
Transformer has to be situated outside of the sofa!

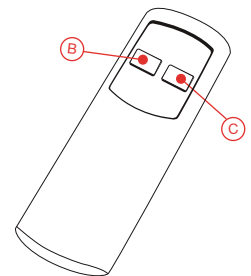
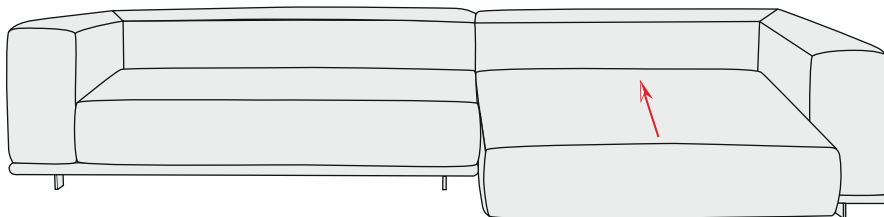
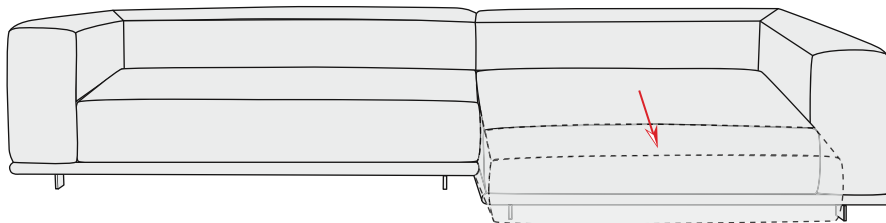

Motorised seat adjustment - Programming of transmitter and receiver

Delivery condition: already synchronised

November 2021

Brief instruction, Pairing-Method:

Should a new start-up of remote control be necessary the wireless communication with the control/motor must be established. Proceed as follows:



1. Press pairing buttons A at receiver 2 x until the LED indicates. The pairing process is active for about 10 seconds.

2. Press simultaneous button B and C at the transmitter until the green LED at the receiver vanishes. This confirms a successful pairing process.

Note: For the pairing process the distance between transmitter and receiver should be less than 2 metres.

The programming is completed, the transmitter is now ready for operation. If the motor doesn't start while pressing, release the button and press again. If necessary retry the process.

The programming is completed, the transmitter is now ready for operation. If the motor doesn't start while pressing, release the button and press again. If necessary retry the process.



Put drive systems into operation successively, **don't** operate several systems simultaneous. Otherwise the remote control cannot be assigned clearly by control/motor.

Technical data – for elements with motor-driven seat adjustment

Electrical connection

To be connected to common household alternating current (AC) with an input voltage of up to 240 V. To ensure a non-hazardous operation, the alternating current from the socket is converted in „low-voltage current“ (direct current, DC) by means of an integrated rectifier and an output voltage of 24 V is output. The main adapter respectively the charging unit also features a protective circuit which prevents malfunctions due to surge voltages and damages to the unit.

Note: The warranty claim will be invalidated if the device is connected incorrectly. Please also pay attention to a proper routing of the mains cable. The drive system is designed for alternating voltage.



Safety notes

The construction of the piece of furniture as well as the used materials ensure that it may be used without causing risks to the user when used as intended and in compliance with the present operating instructions.

All service, maintenance and repair operations shall only be carried out and documented by authorized persons. If it is necessary to disassemble individual safety devices during e.g. service or repair operations, then it is required to perform the re-establishment and examination of the effectiveness of all safety devices immediately upon completion of the operations.

Technical data – for all elements with seat adjustment

Motors

www.kaidielectrical.com

Device type	KDYT...,KDPT...
Mains connection (VAC)	100 - 240 V AC
Motor voltage	29 V DC
Protection type	IP 20
Continuous operation / pause cycles	2 min. / 18 min.

Caution: It is prohibited to put safety devices and/or guards out of operation respectively to remove them! The motor cover must not be removed! The piece of furniture is not suitable for operation in wet rooms!



Accumulator

www.kaidielectrical.com

Device type	KDDY022-2600
Accumulator capacity	approx. 50 Cycles / ø 21 days
Charging of the accumulator	by means of separate charging adapter
Life cycle	approx. 500 charging cycles (depending on use and environment)

Use accumulator only in dry rooms!

Do not dispose of the accumulator in the domestic waste!



Technical data – for all elements with seat adjustment

Notes: Before first operation, please charge the accumulator completely (8 hours). The charging and adjusting is possible at the same time. Recharge the accumulator after 3 months at the latest because otherwise the capacity will suffer. As soon as the critical accumulator capacity is reached, an acoustic alarm signal will sound when the function is activated. Immediately charge the accumulator.



The optimal performance of the accumulator is only ensured at normal room temperature (20° to 30° C).

Accumulators, batteries, electric motors, manual switches etc. belong to the wear and tear parts of a model. They are subject to a continuous loss of performance that differs depending on the intensity of the use (or application respectively purpose). Their lifetime is therefore limited by their very nature. This is part of the normal wear and tear of the parts and does not constitute any valid cause for complaint. If, however, a complaint occurs within the first six months after purchase, it is assumed that a material defect existed already at the beginning. In such cases, we will replace the respective wear and/or tear part.

For wear and tear parts, we herewith provide all pieces of information, among other things regarding charging, connection, operation or storage in order to ensure a proper use. Please understand that failure to follow the instructions and incorrect handling will make claims under warranty null and void for those parts.

Bullfrog
Marketing & Design GmbH

Landwehrstr. 32
96247 Michelau
Germany

declares for the following programme:

Blue 0221 Wumms!, types with motor-driven adjustment

the compliance and the equivalent with the EC guidelines:

EC machinery directive	2006/42/EG
EC low-voltage directive	2006/95/EG
other used standards	EN 60335-1 EN 55014-1 EN 55014-2 Kat II EN 61000-3-2/-3-3

Authorized representative of documents: Jan Beier
Landwehrstr. 32
96247 Michelau
Germany

It is certified herewith, that the above-mentioned products correspond to the mentioned EC guidelines

Michelau, June 2022

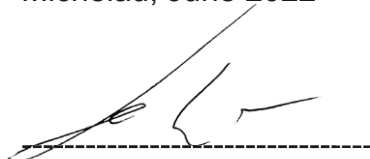

Jan Beier, director of Bullfrog Marketing & Design GmbH