

# ASSEMBLY AND INSTRUCTION MANUAL MODEL OD1037 LETTINO

© 2011 KURT BEIER & KATI QUINGER



www.bullfrog-design.com

Loungers Lettino with intermediate table



Functional lounge Lettino, single or...



...as comfort double lounge



Lettino Twist with swivel function  
and practical concrete table



Flexibility due to practical castors

Footrest, functional back and headrest of type 224/224FD

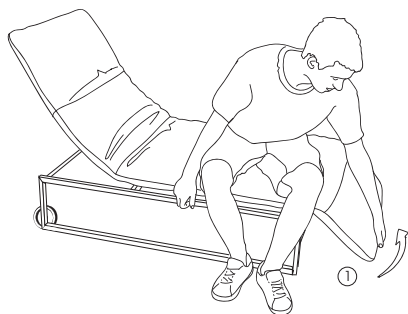

**1. Adjustment of footrest with type 224/224FD (1):**

Grip the footrest at bottom side and pull upwards into your direction until you have reached the desired position.

How to fold down in zero position:

To obtain zero position pull the footrest carefully beyond the top position into your direction and fold down into zero position.

**2. Adjustment of back slant, type 224/224FD (2):**

Grip the back at waist level and pull it carefully into your direction.

To obtain zero position pull the back carefully beyond the top position into your direction and fold down into zero position.

From zero position you can easily snap the back into desired position.

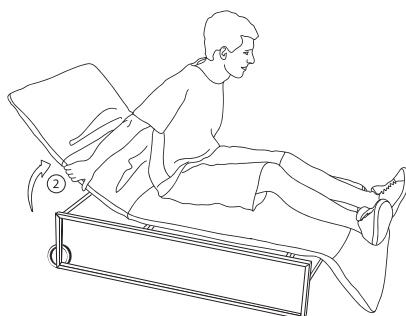

**3. Adjustment at headrest, type 224/224FD (3):**

Grip the head rest and pull it carefully into your direction.

To obtain zero position pull the head rest carefully beyond the last position into your direction and fold down into zero position.

From zero position you can easily snap the head rest into desired position.

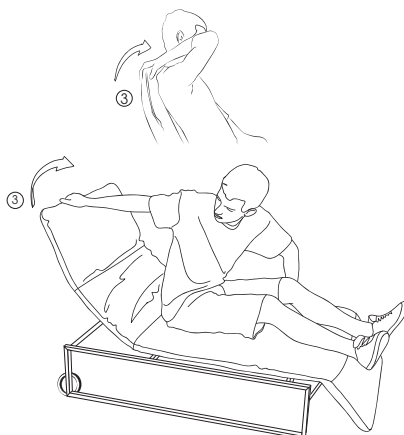

How to insert table 859 for type 224:

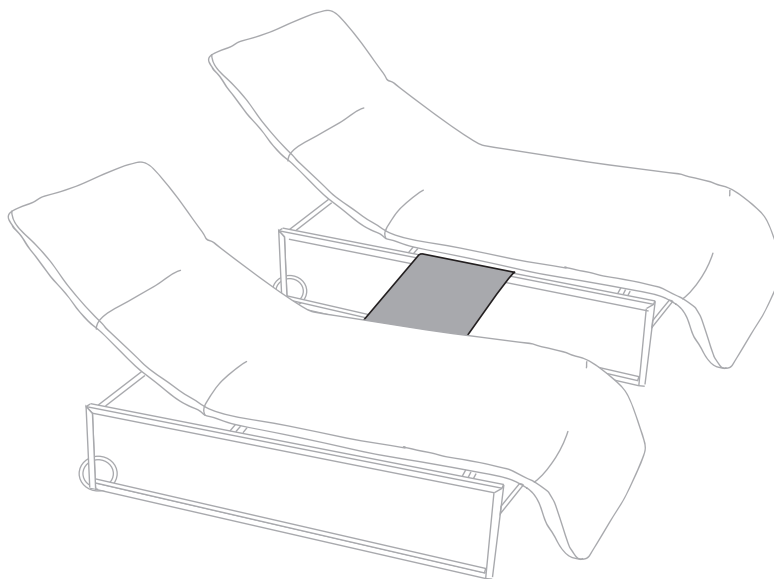
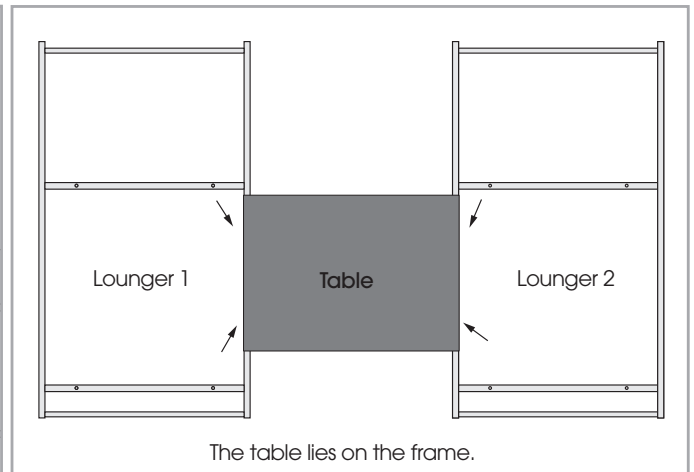
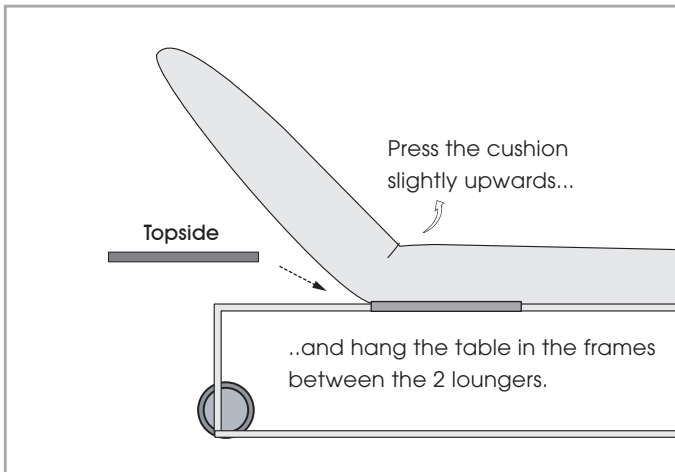
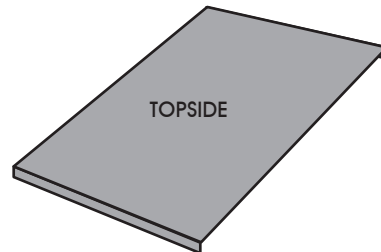

Connector clips VB1 for type 224:

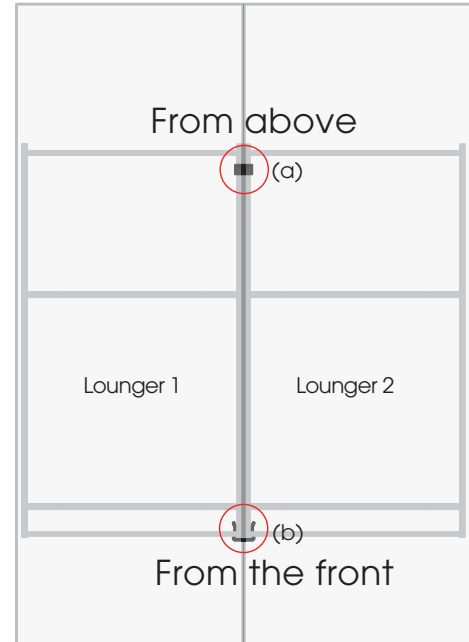
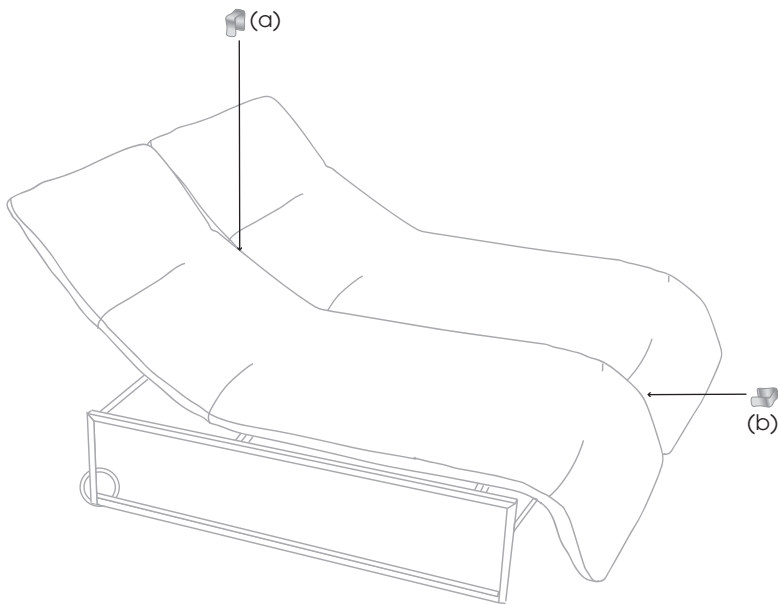

Fixation with  
2 connector clips (VB1)

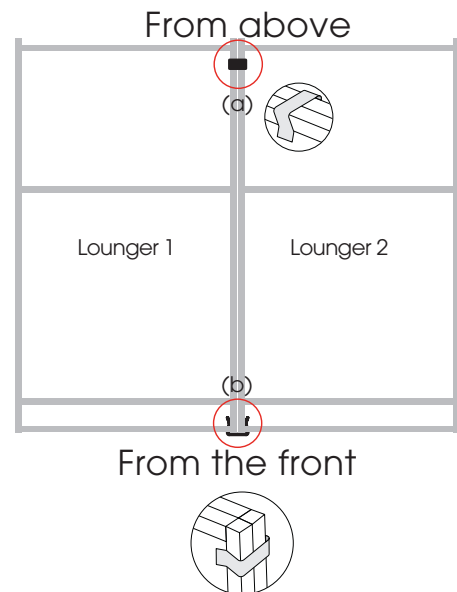
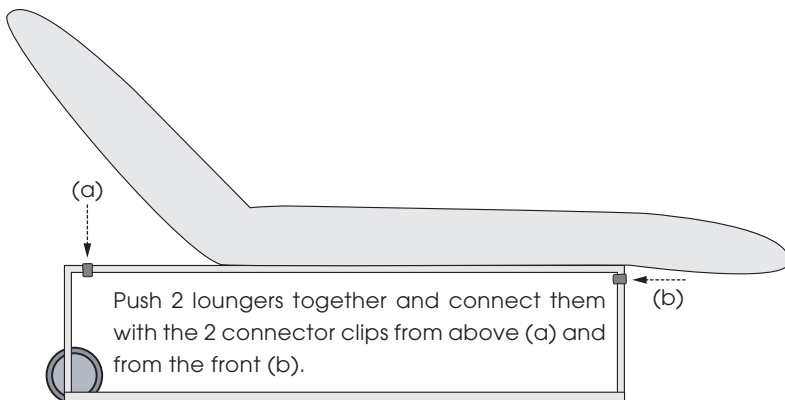

Swivel function, 224FD:

---

