

PRODUCT INFORMATION MODEL 2117 TABLO

© 2018 KURT BEIER & KATI QUINGER



Turn function (360°) and individual adjustment of back



Manual turntable (360°)









Optionally wooden plateau or covered plateau

TABLO: DINNER WITH FRIENDS - A PLACE TO EAT, A PLACE FOR A CHAT - A SPECIAL PLACE FOR SPENDING TIME TOGETHER. SIT RELAXED AND GET UP EASILY. UPHOLSTERED ELEMENTS WITH ADJUSTABLE BACKRESTS AND 360° ROTATE FUNCTION PLACED ON A BENCH. AVAILABLE IN HIGH OR LOW DINING VERSION COVERS IN FABRIC OR LEATHER WITH DIFFERENT SEAM TYPES. DINING TABLES AVAILABLE IN VARIOUS SHAPES. BASE FRAME IN METAL, MATT BLACK OR POWDER COATED. UNIQUE PIECE PRODUCTION.

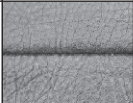
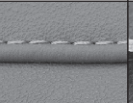
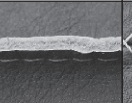

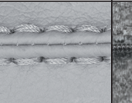
Lower frame: round steel, powder-coated fine structure in black matt

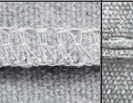
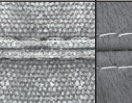
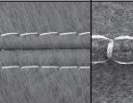
Processing options of main seam / decorative seam

	Plain seam	Lap seam	Raw edged	Moccasin seam extra charge	Twin seam extra charge	KR* (zipper piping) extra charge	Overcast seam extra charge	Piping	Two needle seam	Square seam extra charge
										
Fabric	x	x						x		
Leather	x	x	x							
Fur										
Fake fur	x									

It is possible to order main seam or decorative seam either tone in tone like the colours of cover or in the contrasting colours white, nature, grey, rust and black. On request special colours possible.

*Zipper piping: optionally in the colours black, red, nature or light grey.

Wood, standard surfaces:

	Natural spruce brushed (light puttied)	Spruce brushed, grey stained (Vintage-Style)	Common ash natural (brown puttied)	Ash black stained	Ash black brown	Wild oak (dark puttied)	Beam oak (not puttied)	Old oak (not puttied)	Steamed oak (dark puttied)	Smoked oak (dark puttied)	American walnut (dark puttied)
Price group	PG1	PG1	PG2	PG2	PG2	PG3	PG4	PG4	PG4	PG5	PG6
											
Untreated	∅	∅	*	∅	∅	*	∅	✓	✓	✓	*
Oiled	∅	∅	*	∅	∅	✓	∅	*	*	*	✓
Lacquered	∅	∅	✓	✓	✓	*	✓	*	*	*	*

Untreated wood gets its unique character due to the naturalness. Colour or structure variations from the samples shown are standard and have to be accepted. The wood will get a desired patina overtime with daily use, which emphasizes the character of the wood. For further care please notice the general wood information. Puttied areas may have a different colour appearance depending on the surface. For example, dark putty can look lighter on untreated wood.

* = Available on request against processing surcharge

✓ = Bullfrog recommendation and standard surface

∅ = These variants are not available

Natural stone plate:

Jura grey

Sanded & impregnated

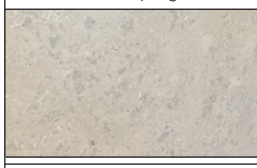

✓

Our natural stone table top, Jura grey, finely polished surface, is a limestone from the Altmühltal near Eichstätt. Its characteristics are the inclusions of fossilized shells and its homogeneous greyish structure. The table tops are treated with a food-safe impregnation at the factory. For daily care, the natural stone can be wiped with a microfiber cloth and a non-acidic, preferably PH neutral soap. Attention! Natural stone is sensitive to acids! Fruit acids, vinegar, lime residues or even tannic acids in red wine, for example, can penetrate the stone and attack the surface.

05.04.2024

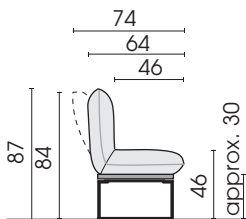

Side view, LOW DINING with cushion 105

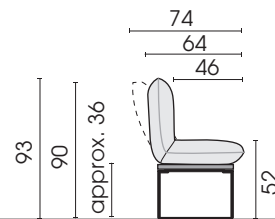

Side view, HIGH DINING with cushion 105

LOW DINING, single components

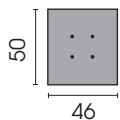

Wood plateau
H = approx. 30 cm
W01L

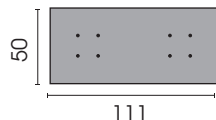

Wood plateau
H = approx. 30 cm
W05L



Wood plateau
H = approx. 30 cm
W07L

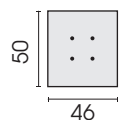

Covered plateau
H = approx. 30 cm
C01L

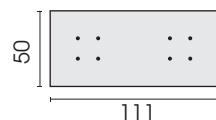

Covered plateau
H = approx. 30 cm
C05L



Covered plateau
H = approx. 30 cm
C07L

**Seating components,
compatible with
Low- and High Dining**

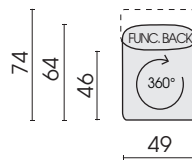

Comfort cushion
105
(105L=left / 105R=right)

HIGH DINING, single components

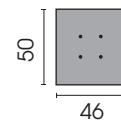

Wood plateau
H = approx. 36 cm
W02H

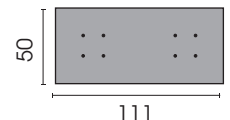

Wood plateau
H = approx. 36 cm
W06H

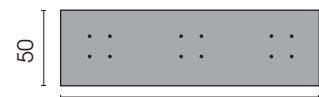

Wood plateau
H = approx. 36 cm
W08H

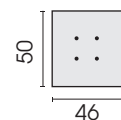

Covered plateau
H = approx. 36 cm
C02H

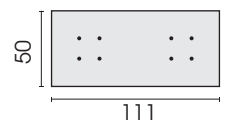

Covered plateau
H = approx. 36 cm
C06H



Covered plateau
H = approx. 36 cm
C08H

Each piece of furniture is handmade and unique. Deviations to the listed measurements may be caused by:
1. different upholstery materials (fabric, leather), 2. processing of ticking mats, 3. the pressure to combine individual parts, etc.
The seat comfort of a sofa type with larger seat depth usually differs from one with lower depth.

LOW DINING*:

Element, comfort cushion, plateau:

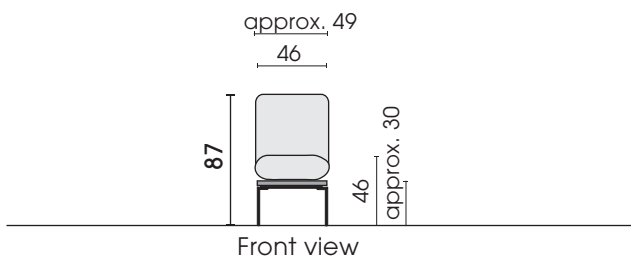

HIGH DINING*:

Element, comfort cushion, plateau:

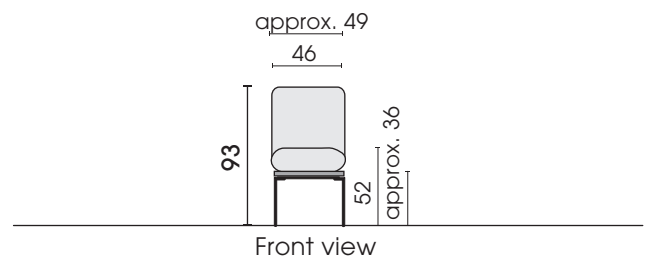

LOW DINING:

Combination, wood plateau

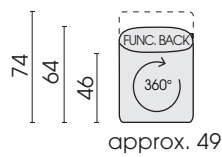

Element Low Dining
comfort cushion
rotatable
1001WL
(105 + W01L)

HIGH DINING:

Combination, wood plateau

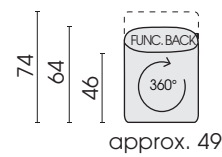

Element High Dining
comfort cushion
rotatable
1002WH
(105 + W02H)

LOW DINING:

Combination, covered plateau

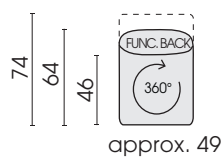

Element Low Dining
comfort cushion
rotatable
1001CL
(105 + C01L)

HIGH DINING:

Combination, covered plateau

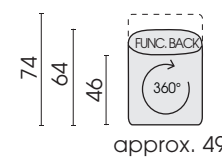

Element High Dining
comfort cushion
rotatable
1002CH
(105 + C02H)

***LOW DINING is suitable for a table height up to approx. 75 cm!!!**

***HIGH DINING is suitable for a table height of approx. 75 cm or higher!!!**

Each piece of furniture is handmade and unique. Deviations to the listed measurements may be caused by:
1. different upholstery materials (fabric, leather), 2. processing of ticking mats, 3. the pressure to combine individual parts, etc.
The seat comfort of a sofa type with larger seat depth usually differs from one with lower depth.

LOW DINING*:

Bench, 2-seat, comfort cushion, plateau:

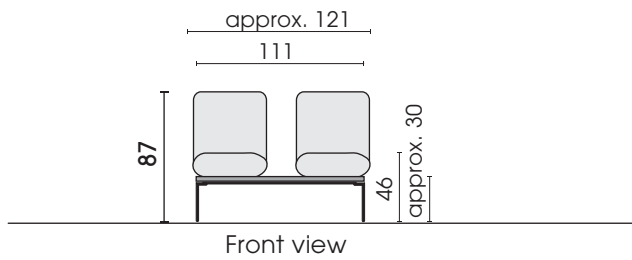

HIGH DINING*:

Bench, 2-seat, comfort cushion, plateau:

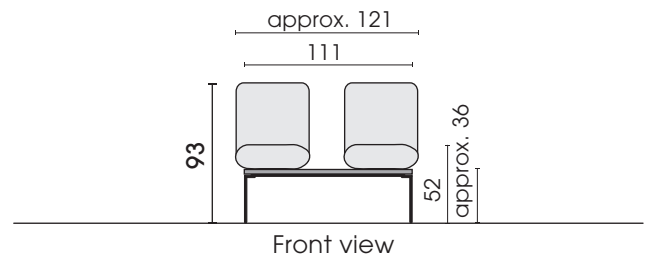

LOW DINING:

Combination, wood plateau

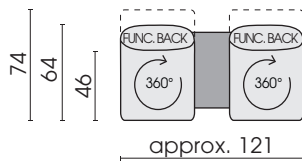

Bench Low Dining
comfort cushion
rotatable
1005WL
(105L + 105R + W05L)

HIGH DINING:

Combination, wood plateau

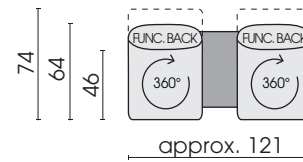

Bench High Dining
comfort cushion
rotatable
1006WH
(105L + 105R + W06H)

LOW DINING:

Combination, covered plateau

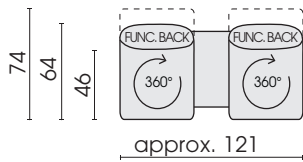

Bench Low Dining
comfort cushion
rotatable
1005CL
(105L + 105R + C05L)

HIGH DINING:

Combination, covered plateau

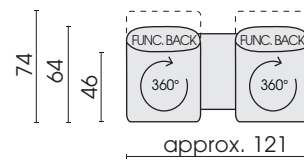

Bench High Dining
comfort cushion
rotatable
1006CH
(105L + 105R + C06H)

***LOW DINING is suitable for a table height up to approx. 75 cm!!!**

***HIGH DINING is suitable for a table height of approx. 75 cm or higher!!!**

Each piece of furniture is handmade and unique. Deviations to the listed measurements may be caused by:
1. different upholstery materials (fabric, leather), 2. processing of ticking mats, 3. the pressure to combine individual parts, etc.
The seat comfort of a sofa type with larger seat depth usually differs from one with lower depth.

LOW DINING*:

Bench, 3-seat, comfort cushion, plateau:

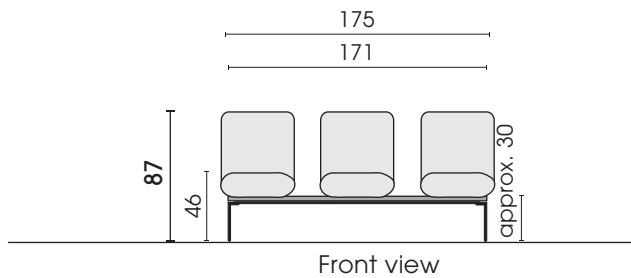

HIGH DINING*:

Bench, 3-seat, comfort cushion, plateau:

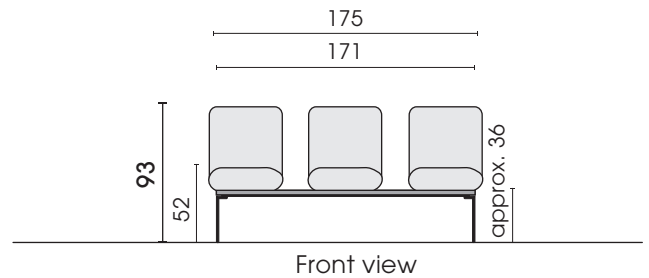

LOW DINING:

Combination, wood plateau

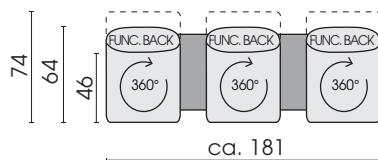

Bench Low Dining
comfort cushion
rotatable
1007WL

(105L + 105M + 105R + W07L)

HIGH DINING:

Combination, wood plateau

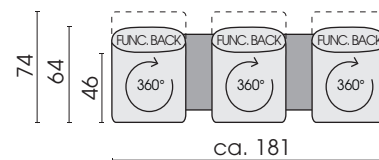

Bench High Dining
comfort cushion
rotatable
1008WH

(105L + 105M + 105R + W08H)

LOW DINING:

Combination, covered plateau

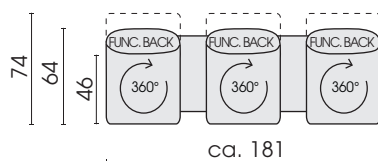

Bench Low Dining
comfort cushion
rotatable
1007CL

(105L + 105M + 105R + C07L)

HIGH DINING:

Combination, covered plateau

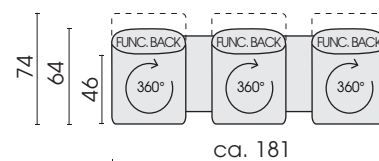

Bench High Dining
comfort cushion
rotatable
1008CH

(105L + 105M + 105R + C08H)

***LOW DINING is suitable for a table height up to approx. 75 cm!!!**

***HIGH DINING is suitable for a table height of approx. 75 cm or higher!!!**

Each piece of furniture is handmade and unique. Deviations to the listed measurements may be caused by:
1. different upholstery materials (fabric, leather), 2. processing of ticking mats, 3. the pressure to combine individual parts, etc.
The seat comfort of a sofa type with larger seat depth usually differs from one with lower depth.

LOW DINING* with cushion 305

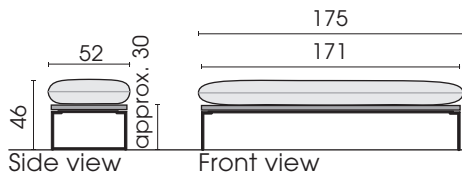

HIGH DINING* with cushion 305

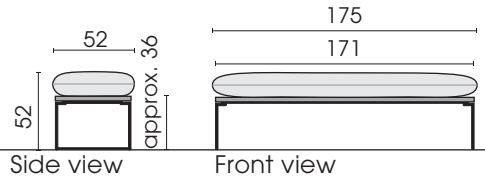

LOW DINING*, bench with comfort cushion without back

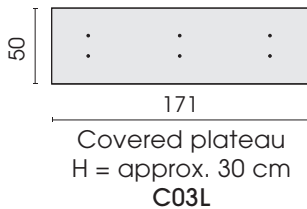
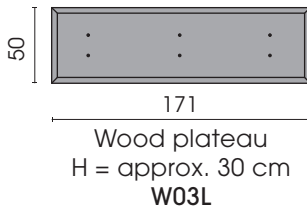

Seating components, compatible with Low- and High Dining

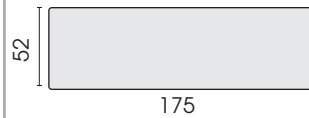

Comfort cushion without back 305
(compatible only with plateau: W03L/C03L / W04L/C04L)

HIGH DINING*, bench with comfort cushion without back

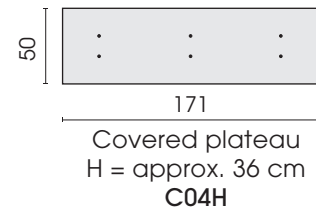
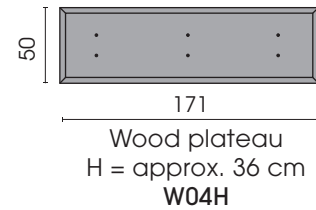

LOW DINING, combination, wood plateau:



Bench Low Dining without back comfort cushion 3003WL (305 + W03L)

LOW DINING, combination, covered plateau:

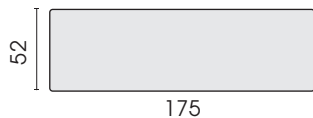

Bench Low Dining without back comfort cushion 3003CL (305 + C03L)

HIGH DINING, combination, wood plateau:



Bench High Dining without back comfort cushion 3004WH (305 + W04H)

HIGH DINING, combination, covered plateau:

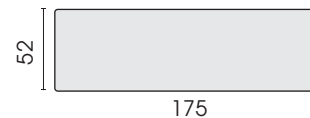

Bank High Dining without back comfort cushion 3004CH (305 + C04H)

***LOW DINING is suitable for a table height up to approx. 75 cm!!!**

***HIGH DINING is suitable for a table height of approx. 75 cm or higher!!!**

Each piece of furniture is handmade and unique. Deviations to the listed measurements may be caused by:
1. different upholstery materials (fabric, leather), 2. processing of ticking mats, 3. the pressure to combine individual parts, etc.
The seat comfort of a sofa type with larger seat depth usually differs from one with lower depth.

Tables, **LOW DINING:**

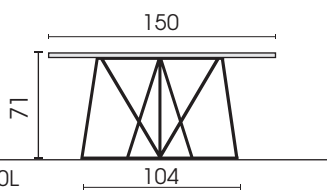

Side view type TR150L/TQ150L

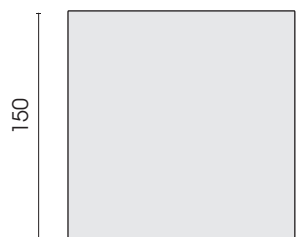

Dining table
TQ150L

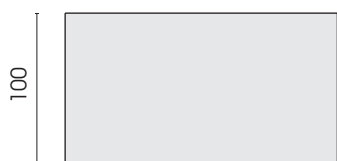

Dining table
T180L

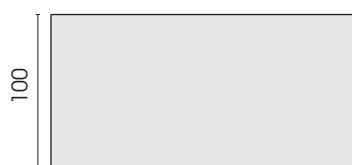

Dining table
T200L

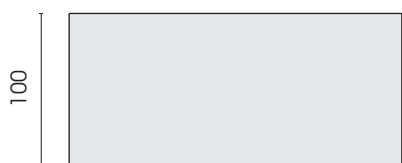

Dining table
T220L

Tables, **HIGH DINING:**

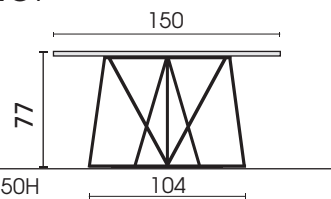

Side view type TR150H/TQ150H

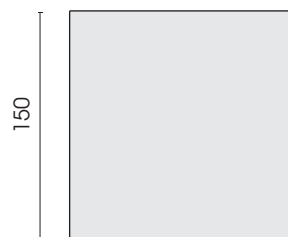

Dining table
TQ150H

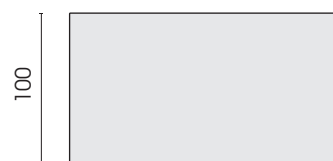

Dining table
T180H

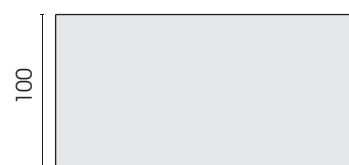

Dining table
T200H



Dining table
T220H

Each piece of furniture is handmade and unique. Deviations to the listed measurements may be caused by:
1. different upholstery materials (fabric, leather), 2. processing of ticking mats, 3. the pressure to combine individual parts, etc.
The seat comfort of a sofa type with larger seat depth usually differs from one with lower depth.

Tables, **LOW DINING:**

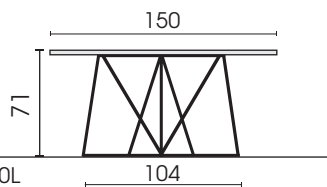

Side view type TR150L/TQ150L

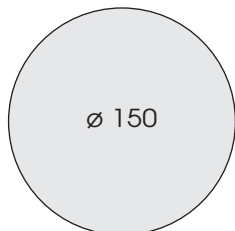

∅ 150

Dining table, ∅150
TR150L

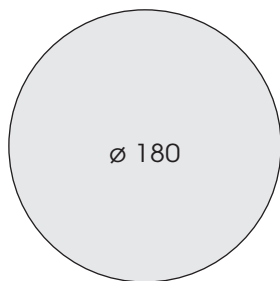

∅ 180

Dining table, ∅180
TR180L

Tables, **HIGH DINING:**

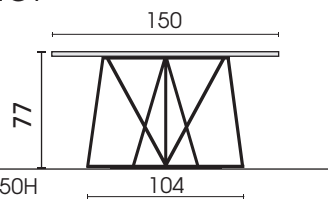

Side view type TR150H/TQ150H

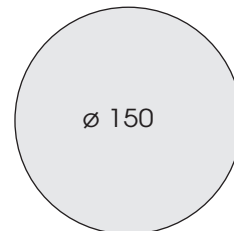

∅ 150

Dining table, ∅150
TR150H

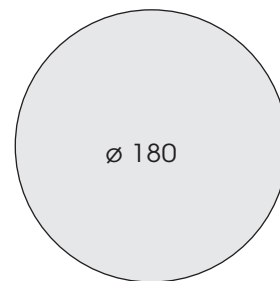

∅ 180

Dining table, ∅180
TR180H

Table, including insertable turntable (flush with the adjacent areas), **LOW DINING:**

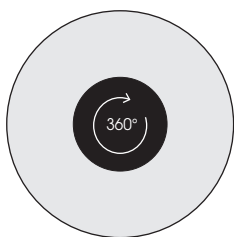

Insertable turntable:
metal plate, powder-coated
fine structure in black matt

Dining table, ∅150
with inserted turntable, ∅62
TR150RL

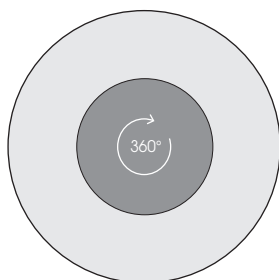

Insertable turntable:
Natural stone plate,
Jura, grey

Dining table, ∅180
with inserted turntable, ∅90
TR180RL

Table, including insertable turntable (flush with the adjacent areas), **HIGH DINING:**

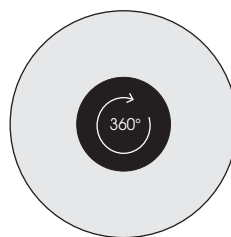

Insertable turntable:
metal plate, powder-coated
fine structure in black matt

Dining table, ∅150
with inserted turntable, ∅62
TR150RH

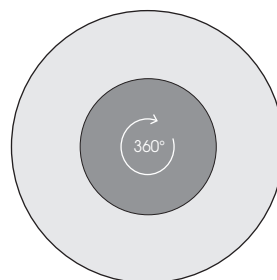

Insertable turntable:
Natural stone plate,
Jura, grey

Dining table, ∅180
with inserted turntable, ∅90
TR180RH

Each piece of furniture is handmade and unique. Deviations to the listed measurements may be caused by:

1. different upholstery materials (fabric, leather), 2. processing of ticking mats, 3. the pressure to combine individual parts, etc.
- The seat comfort of a sofa type with larger seat depth usually differs from one with lower depth.

Additional turntable, compatible with the following dining tables:

- TR150L / TR150H
- TQ150L / TQ150H
- T180L / T180H
- T200L / T200H
- T220L / T220H



Turntable
 ø 62 cm
 H=2,5 cm
TR70

Additional turntable: metal plate, matt black fine structure powder-coated

Coffee tables:

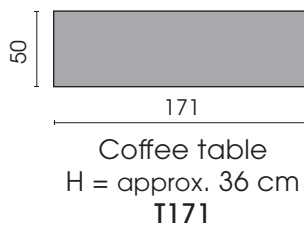
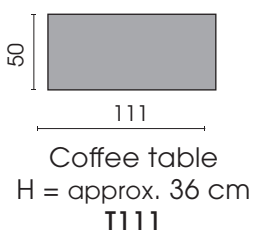
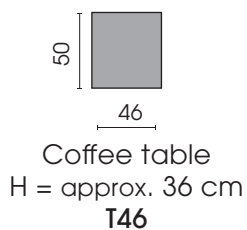
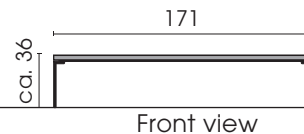
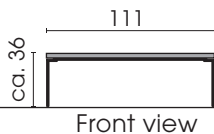
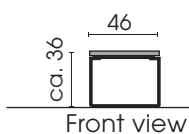

Each piece of furniture is handmade and unique. Deviations to the listed measurements may be caused by:
 1. different upholstery materials (fabric, leather), 2. processing of ticking mats, 3. the pressure to combine individual parts, etc.
 The seat comfort of a sofa type with larger seat depth usually differs from one with lower depth.

Combinations:

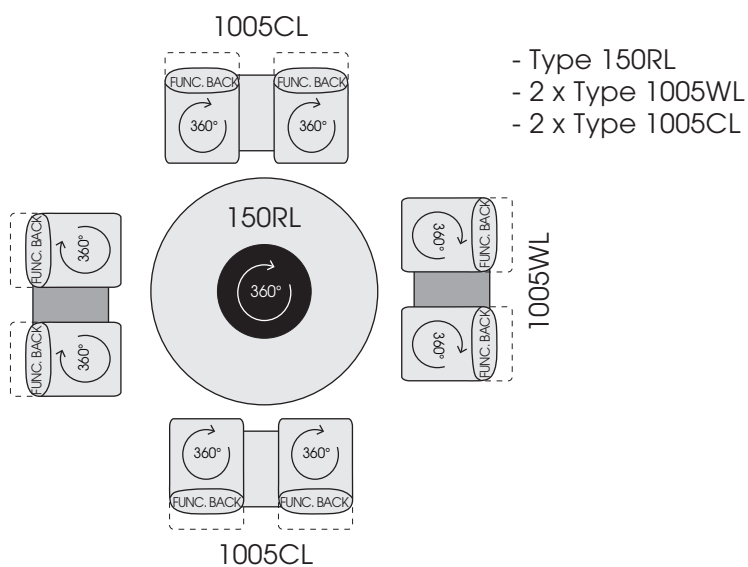
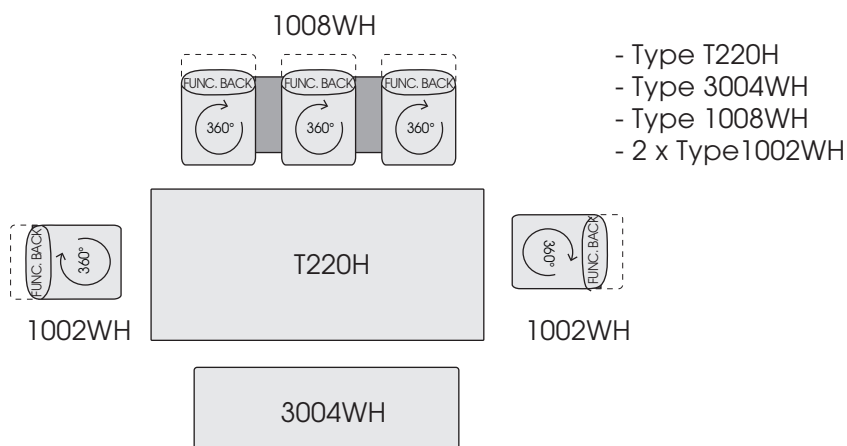

Each piece of furniture is handmade and unique. Deviations to the listed measurements may be caused by:
 1. different upholstery materials (fabric, leather), 2. processing of ticking mats, 3. the pressure to combine individual parts, etc.
 The seat comfort of a sofa type with larger seat depth usually differs from one with lower depth.