

# PRODUCT INFORMATION MODEL OD1121 OLALA

© 2021 KURT BEIER & KATI QUINGER



Table with concrete top



Rotation function (360°)  
and individual  
back adjustment



Filigree base frame,  
metal, powder-coated  
fine structure in black matt



Quality outdoor solid wood  
in different wood variants or  
concrete and natural stone table tops



## OD OLALA ...:

HOMELY TABLE AT BAR HEIGHT WITH FINE METAL BASE OFFERING AN INTEGRATED COMFORTABLE FOOTREST. PLUS BENCHES AND STOOLS WITH SWIVEL SEATS AND COMFORTABLE BACKS WITH LATCHING FUNCTION. A CONVIVIAL PLACE THAT BECOMES THE CENTER OF ANY LOCATION. UNIQUE PIECE PRODUCTION.

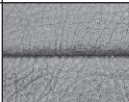
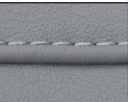

**Base frame:** metal, powder-coated fine structure in black matt.

### Processing options of main seam / decorative seam

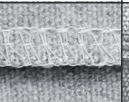
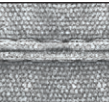

	Plain seam	Lap seam	KR* (zipper piping) extra charge	Overcast seam extra charge	Piping
					
Outdoor fabric	x				
Outdoor leather	x				

\*Zipper piping: optionally in the colours black, red, nature or light grey.

### Outdoor innercover

Additional protection against moisture penetration is provided by an inner cover made of waterproof fabric. The inner cover can be selected for the respective model at an extra charge. Please specify when ordering.

### Outdoor wood, standard surfaces:

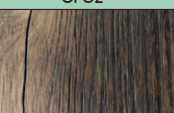
	Larch	Thermoash	Beam oak
	(brown puttied)	(brown puttied)	(not puttied)
Price group	OPG1	OPG2	OPG2
			
Untreated	*	∅	∅
Oiled	✓	✓	*
Lacquered	*	*	✓

Puttied areas may have a different colour appearance depending on the surface. For example, dark putty can look lighter on untreated wood.

\* = Available on request against processing surcharge  
 ✓ = Bullfrog recommendation and standard surface  
 ∅ = These variants are not available

### Natural stone table tops TS130

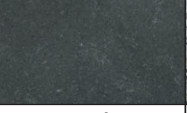
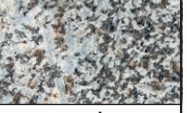
	Jura marble	Nero Assoluto granite	Flossenbürger granite
	polished	satin-finished	satin-finished
			
Impregnated	✓	✓	✓

The tabletops are factory-treated with a food-safe impregnation. For daily care, the natural stone can be wiped with a microfiber cloth and a non-acidic, preferably pH-neutral soap. Stains should be removed immediately to prevent them from penetrating the stone.

### Concrete table top TB130

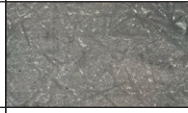
	Concrete	
		Our concrete table tops are made of poured concrete. Their low material thickness with high stability is achieved by a glass fibre reinforcement. The concrete table top is coloured throughout and the surface is oiled. Due to the open structure, colour shading may occur on the surface. The table top is light, UV and weather resistant.
Oiled	✓	

**Model OD1121 Olala is also available as indoor product!**

**For further informations refer to product information 1121 Olala.**

25.04.2025

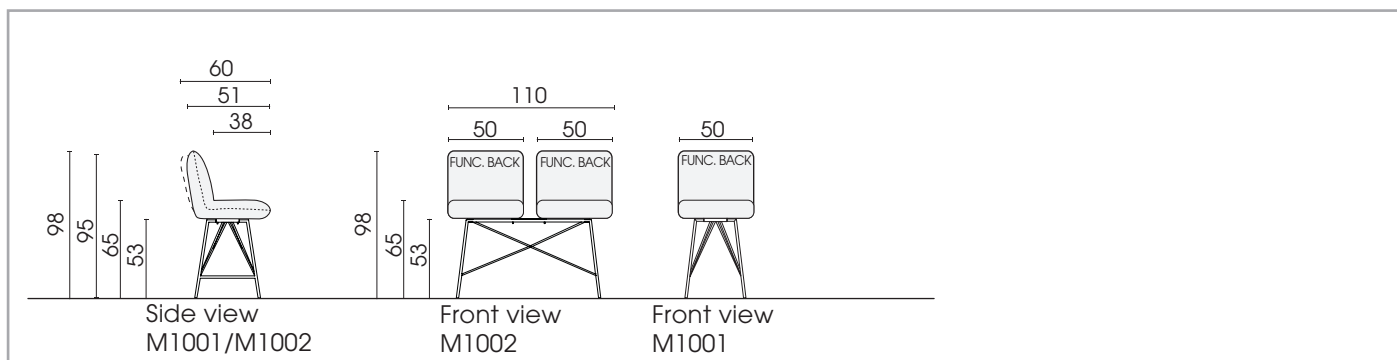

**Unicoloured processing, seating elements**  
(incl. lower frame):

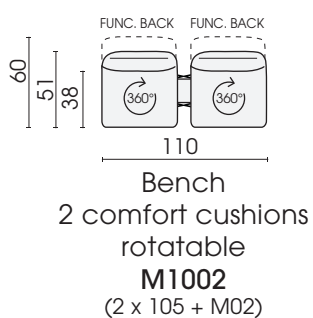
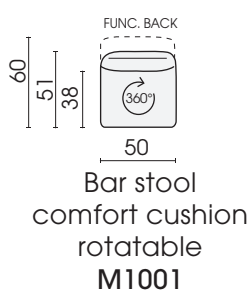

**Two-coloured processing, seating elements:**

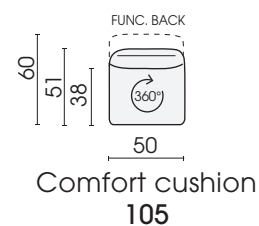
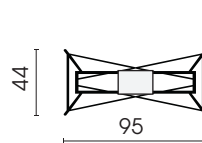

2 elements 105 always have to be mounted on plateau M02!

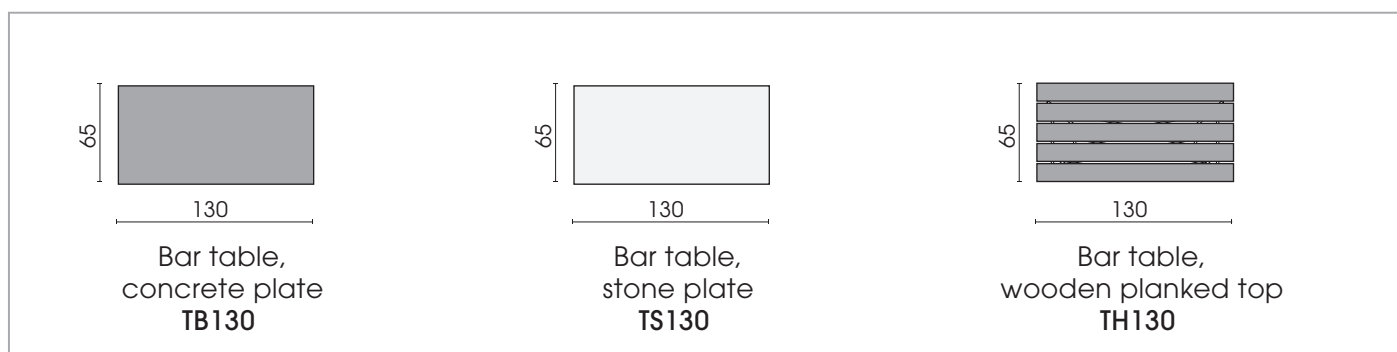
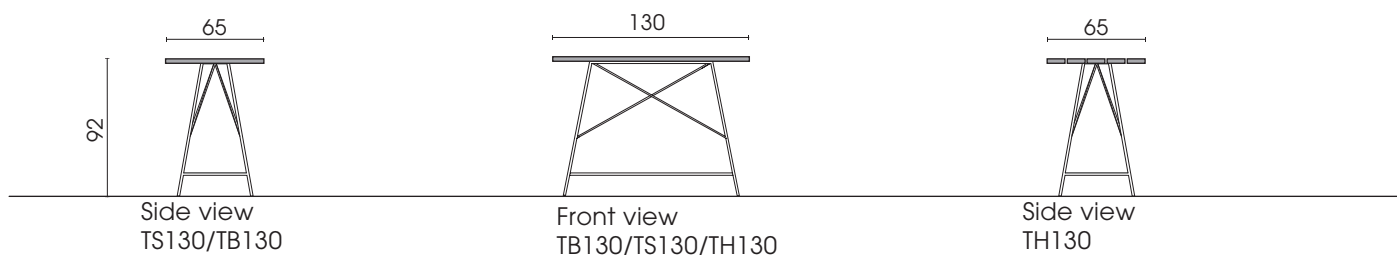

Protective covers (Waterproof)

Protective cover for type M1001: SHM01

Protective cover for type M1002: SHM02

Protective cover for type TH130/TB130/TS130: SHT130

Protective cover for combination (1 x bar table + 2 x bench + 2 x stool): SHK1

Each piece of furniture is handmade and unique. Deviations to the listed measurements may be caused by:  
1. different upholstery materials (fabric, leather), 2. processing of ticking mats, 3. the pressure to combine individual parts, etc.  
The seat comfort of a sofa type with larger seat depth usually differs from one with lower depth.